

barkman™

Barkman Landscape Kits

Quarry Stone Curved Bar

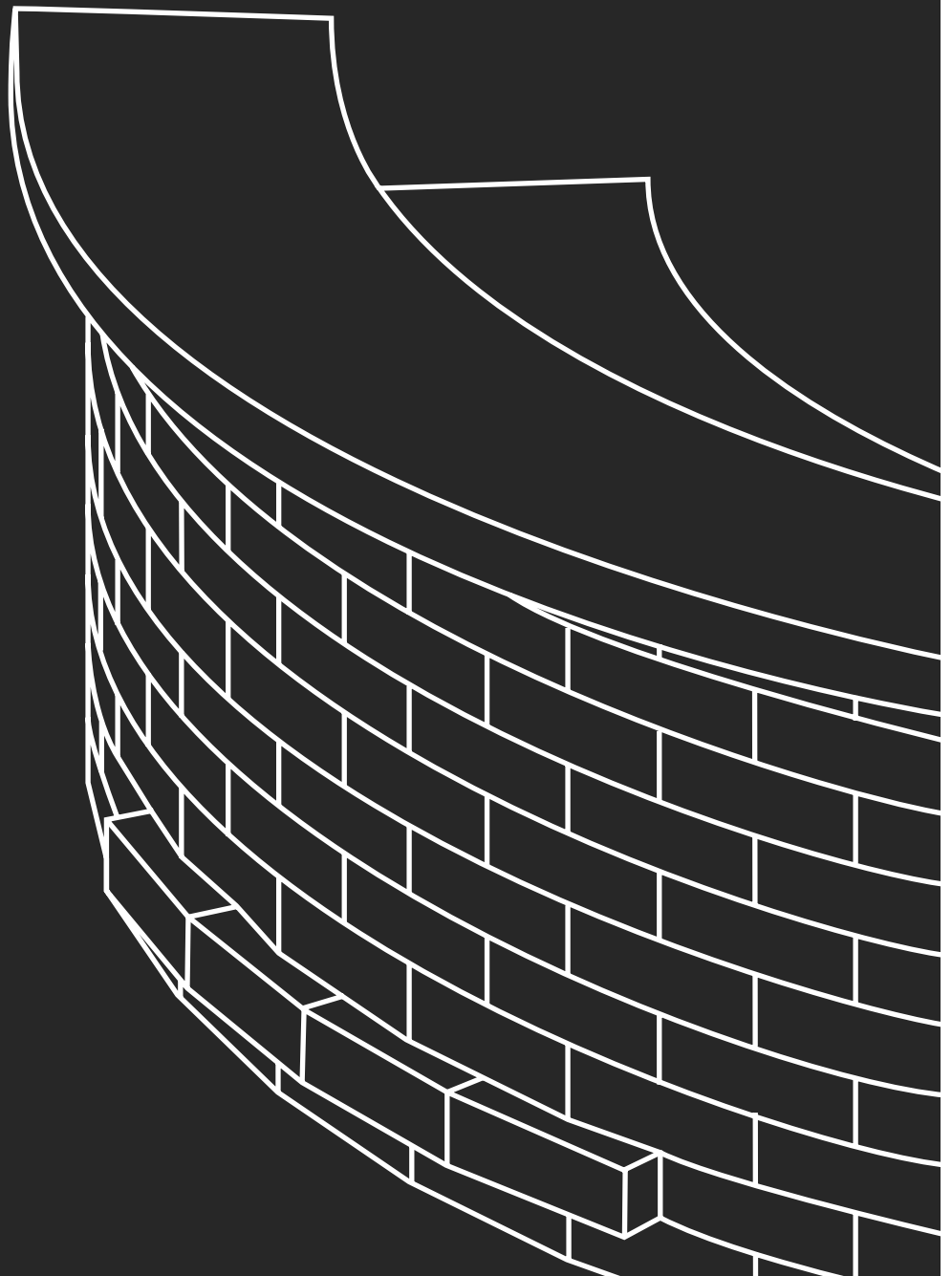

Materials

This kit measures 64.19" x 31" x 37.5"

MATERIALS INCLUDED:

- 12" Quarry Stone Radius – 65 pieces
- 12" Quarry Stone Radius Half Piece – 8 pieces
- 12" Quarry Stone Radius cut to 7" – 2 pieces
- 12" x 8" Quarry Stone – 16 pieces
- 4" x 8" Quarry Stone – 14 pieces
- 3" x 15" x 7'6" Countertop
- 3" x 20" x 6' Countertop
- Plastic Shims
- Tube of Landscape Glue
- Gloves
- Instruction Guide

OTHER ITEMS NEEDED:

- Rubber Mallet
- Caulking Gun
- Measuring Tape/Ruler
- Level

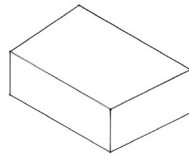

12" Quarry Stone Radius

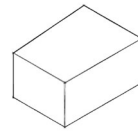

12" Quarry Stone Radius Half Piece

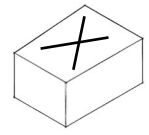

12" Quarry Stone Radius cut to 7"

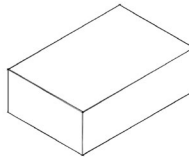

12" x 8" Quarry Stone

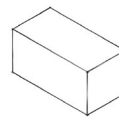

4" x 8" Quarry Stone

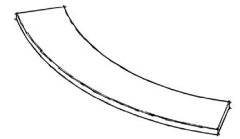

3" x 15" x 7'6" Countertop

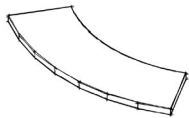

3" x 20" x 6' Countertop

Base Preparation

If installing your Barkman Quarry Stone Curved Bar on an unstructured base, please ensure to follow these steps:

- Excavate area approx. 5 inches below grade.
- Excavate approx. 6 inches larger than your actual kit dimensions to ensure a stable base.
- Fill 4" with $\frac{3}{4}$ inch down limestone and compact firmly.
- Level out $\frac{1}{2}$ inch of sand and install kit as per the instruction guide.

If you are installing on a solid base such as an existing patio, base prep is not necessary. Please proceed to the first step.

These instructions may not refer to all base conditions. As this kit is incredibly heavy, base prep will greatly depend on existing ground conditions and may require alternate techniques.

Note: This manual was updated on May 2021. For manual updates, check www.barkmanconcrete.com/resources

Instructions

1

- A** Lay down the first layer as shown in the diagram.
- B** Check that stones are level at every step. Use included shims for adjustments.

USE:
(7) 12" Quarry Stone Radius blocks
(2) 12" x 8" Quarry Stone blocks
(2) 4" x 8" Quarry Stone blocks



2

- A** Lay down the second layer as shown in the diagram.
- B** Check that stones are level at every step. Use included shims for adjustments.

USE:
(6) 12" Quarry Stone Radius blocks
(2) 12" Quarry Stone Radius cut blocks
(2) 12" x 8" Quarry Stone blocks
(2) 4" x 8" Quarry Stone blocks



3

- A** Lay down the third layer as shown in the diagram.
- B** Check that stones are level at every step. Use included shims for adjustments.

USE:
(7) 12" Quarry Stone Radius blocks
(2) 12" x 8" Quarry Stone blocks
(2) 4" x 8" Quarry Stone blocks



4

- A** Lay down the fourth layer as shown in the diagram.
- B** Check that stones are level at every step. Use included shims for adjustments.

USE:

- (6) 12" Quarry Stone Radius blocks
- (2) 12" Quarry Stone Radius Half Piece blocks
- (2) 12" x 8" Quarry Stone blocks
- (2) 4" x 8" Quarry Stone blocks

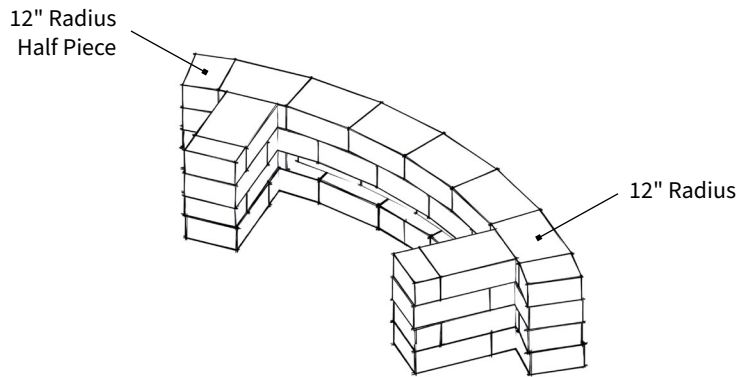

5

- A** Repeat the patterns from Step 3 and 4 until there are 8 layers total. The 4" x 8" blocks are omitted from the 8th layer.
- B** Align the 12" x 8" blocks from layer 8 with the 12" x 8" blocks from layer 7.
- C** Check that stones are level. Use included shims for adjustments.

USE:

- (26) 12" Quarry Stone Radius blocks
- (4) 12" Quarry Stone Radius Half Piece blocks
- (8) 12" x 8" Quarry Stone blocks
- (6) 4" x 8" Quarry Stone blocks

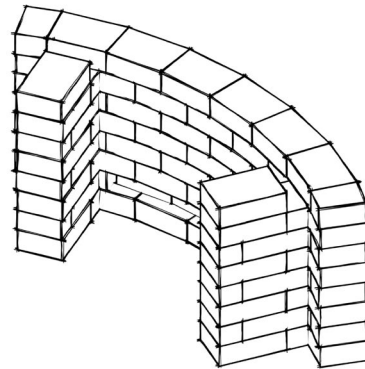

6

- A** Repeat the patterns from Step 3 and 4 using only tapered Quarry Stone to complete layers 9 and 10.
- B** Glue layer 10 to layer 9 to hold it in place.
- C** Check that stones are level. Use included shims for adjustments.

USE:

- (13) 12" Quarry Stone Radius blocks
- (2) 12" Quarry Stone Radius Half Piece blocks

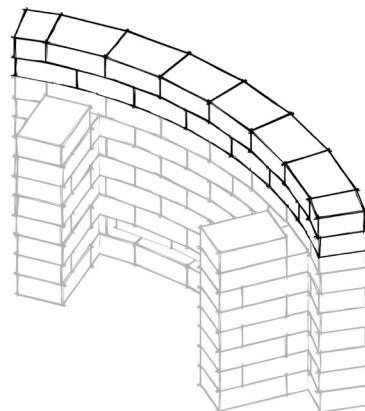

7

- A** Place the countertops as shown in the diagram.
- B** Make sure that they are level on all sides then glue countertops in place.

USE:

- 3" x 15" x 7'6" Countertop
- 3" x 20" x 6' Countertop

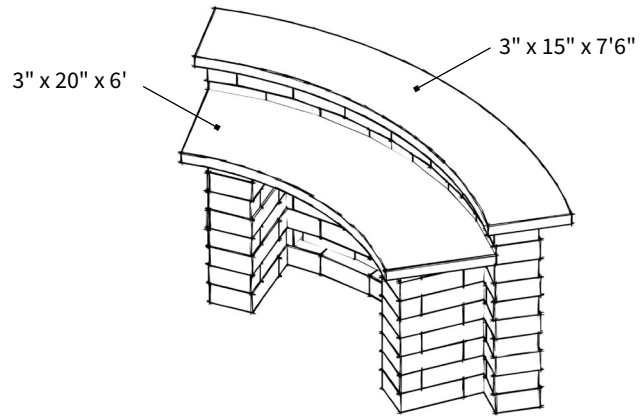

barkman™

STEINBACH OFFICE

152 Brandt Street,
Steinbach, MB R5G 0R2
T 204 326 3445 or 1 800 461 2278
F 204 326 5915
Steinbach@BarkmanConcrete.com

WINNIPEG OFFICE

901 Gateway Road,
Winnipeg, MB R2K 3L1
T 204 667 3310 or 1 800 342 2879
F 204 663 4854
Winnipeg@BarkmanConcrete.com

CALGARY OFFICE

813 McCool Street, Box 1136,
Crossfield, AB T0M 0S0
T 403 946 4630 F 403 946 4631
Calgary@BarkmanConcrete.com

VANCOUVER OFFICE

2104-290 Newport Drive,
Port Moody, BC V3H 5N2
T 778 689 7670 or 1 800 461 2278
F 604 949 0321
Vancouver@BarkmanConcrete.com

SASKATOON DISTRIBUTION CENTER

3550 Idylwyld Drive North,
Saskatoon, SK S7L 6G3
T 1 306 549 7544

KELOWNA DISTRIBUTION CENTER

1904 Old Okanagan Highway,
Westbank, BC V4T 1T8
T 1 204 346 9490

SURREY DISTRIBUTION CENTER

8157 132nd Street,
Surrey, BC V3W 4N5
T 1 204 346 9490

BARKMAN CONCRETE LIMITED

BarkmanConcrete.com

