



# ROSETTA® GRAND LEDGE

## UNIT OF MEASURE

The Unit of Measure for Rosetta Grand Ledge is Pallet.

## INSTALLATION

For information on wall heights, consult the product installation guide and technical specifications. Check your local building codes and consult a professional engineer when required.

## PALLET INFORMATION

Sold in full pallets only. Contact your local Barkman sales representative for further details.

## PALLET CONFIGURATIONS

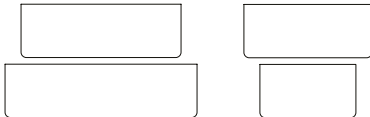

Pallet Layer 1

Pallet Layer 2

## STANDARD WALL SPECIFICATIONS

12 X 36 X 20	UNIT (H X W X D)		
	SIZE	WEIGHT	
	MM 305 x 914 x 508	KG 300	
	IN 12 x 36x 20	LB 660	
12 X 48 X 20	UNIT		
	SIZE (H X W X D)	WEIGHT	
	MM 305 x 1138 x 508	KG 405	
	IN 12 x 48 x 20	LB 890	
12 X 60 X 20	UNIT (H X W X D)		
	SIZE	WEIGHT	
	MM 305 x 1443x 508	KG 490	
	IN 12 x 60 x 20	LB 1080	
12 X 72 X 20	UNIT (H X W X D)		
	SIZE	WEIGHT	
	MM 305 x 1748 x 508	KG 610	
	IN 12 x 72x 20	LB 1350	
GRAND LEDGE PALLET	PALLET		
	LAYERS	UNITS	WEIGHT
	2	4	M2 1.67
			SQFT 18
			KG 1805
			LB 3980

## COLOURS



Copper Canyon



Fond du Lac



Northern Charcoal



Pacific Grey





# ROSETTA® GRAND LEDGE

## UNIT OF MEASURE

The Unit of Measure for Rosetta Grand Ledge is Pallet.

## INSTALLATION

For information on wall heights, consult the product installation guide and technical specifications. Check your local building codes and consult a professional engineer when required.

## PALLET INFORMATION

Sold in full pallets only. Contact your local Barkman sales representative for further details.

## PALLET CONFIGURATIONS





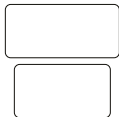

Pallet Layer 1



Pallet Layer 2

## FREE-STANDING WALL SPECIFICATIONS

E: 12 X 36 X 20	UNIT (H X W X D)		
	SIZE	WEIGHT	
	MM 305 x 914 x 508	KG 283	
	IN 12 x 36 x 20	LB 623	
B: 12 X 42.75 X 19.75	UNIT		
	SIZE (H X W X D)	WEIGHT	
	MM 305 x 1088 x 502	KG 345	
	IN 12 x 42.75 x 19.75	LB 760	
C: 12 X 46 X 21	UNIT (H X W X D)		
	SIZE	WEIGHT	
	MM 305 x 1168 x 533	KG 395	
	IN 12 x 46 x 21	LB 880	
F: 12 X 54 X 20	UNIT (H X W X D)		
	SIZE	WEIGHT	
	MM 305 x 1372 x 508	KG 437	
	IN 12 x 54 x 20	LB 963	
GRAND LEDGE PALLET	PALLET		
	LAYERS	UNITS	FACE AREA
	2	4	M2 1.39
			SQFT 14.9
			WEIGHT
			KG 1463
			LB 3226

## COLOURS



Copper Canyon



Fond du Lac



Northern Charcoal



Pacific Grey



# WALL ASSEMBLY

## 90° OUTSIDE CORNER

Any combination of Grand Ledge freestanding blocks **B, C, E,** and **F** can be used for the construction of typical outside corners.

Pattern shown utilizes **B, C, E,** and **F** freestanding blocks. For walls abutting vertical constraints on either side of the corner and for double outside 90° corners, a different configuration is required to limit the cutting of blocks.

- 1 Overlap freestanding blocks, alternating direction for each row.
- 2 Block lengths as specified per project layout.

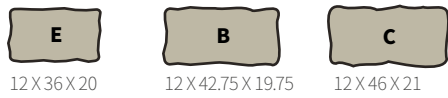

Retaining Wall Blocks      Freestanding Blocks

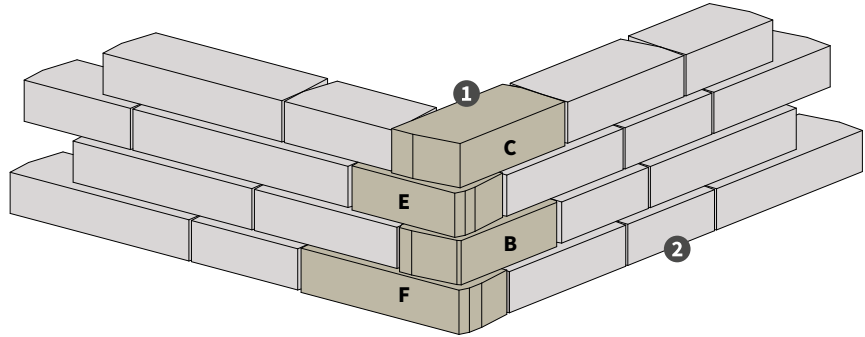

## MINIMUM RADIUS CURVE

Minimum radii shown are based on an average mix of block lengths. The actual radius will depend upon block placement.

Due to setback between rows of blocks, the radius of the convex curves will get smaller towards the top of the wall (2.25 inches per row). Allow extra radius for the bottom row to avoid the upper rows becoming too tight.

- 3 **Convex Curves**  
Minimum radius: 20 ft (6.1 m)  
Best fit radius: >30 ft (9.1 m)

- 4 **Concave Curves**  
Minimum radius: 20 ft (6.1 m)  
Best fit radius: >30 ft (9.1 m)

